

480

SERVICE
MANUAL

PM-50

4822 725 50885



marantz®

model PM-50

Integrated Amplifier

MARANTZ DESIGN AND SERVICE

Using superior design and selected high grade components, MARANTZ company has created the ultimate in stereo sound.

Only **original MARANTZ parts** can insure that your MARANTZ product will continue to perform to the specifications for which it is famous.

Parts for your MARANTZ equipment are generally available to our National Marantz Subsidiary or Agent.

ORDERING PARTS:

Parts can be ordered either by mail or by telex. In both cases, correct part number has to be specified. The following information must be supplied to eliminate delays in processing your order:

1. Complete address
2. Complete part numbers and quantities required
3. Description of parts
4. Model number for which part is required
5. Way of shipment
6. Signature: any order form or telex must be signed otherwise such part order will be considered as null and void.

MARANTZ INTERNATIONAL

Vestdijk 9
5600 MD Eindhoven
The Netherlands
Phone: +31/40.758290
Telefax: +31/40.75.82.99
Telex: 35000 PHTC NL routing IND NLMTFAT

PARTS ORDERING

Parts may be ordered at the following addresses:

AUSTRIA

HORNYPHON
Vertriebsgesellschaft GmbH
Wienerbergstrasse 1
A 1101 Wien
Austria
Telex: 132.332

BELGIUM

SVD DIVISION MARANTZ
Industrialaan 1
1720 Groot-Bijgaarden
Belgium
Telex: 24466

CHILE

MARANTZ
DIVISION OF PHILIPS S.A.
AV. Santa Maria, 0760
Casilla 2687
Santiago
Telex: 240.239

DENMARK

MARANTZ
DIVISION OF PHILIPS
SERVICE A/S
Prags Boulevard 80
Postbox 1919
DK-2300 København S
Denmark
Telex: 31201

FINLAND

MARANTZ
DIVISION OF OY PHILIPS Ab
Kaivokatu 8
00100 Helsinki
Finland
Telex: 124811

FRANCE

MARANTZ FRANCE
4 Rue Bernard Palissy
92600 Asnières
France
Telex: 611651

GERMANY

MARANTZ GERMANY GmbH
Max-Planck-Strasse 22
6072 Dreieich 1
Germany
Telex: 529821

THE NETHERLANDS

Elpro Marantz
Wint Hontlaan 28
3526 KV Utrecht
The Netherlands
Telex: 4748

NORWAY

MARANTZ
DIVISION OF PHILIPS A/S
Sandstuveien 40
0680 Oslo 6
Norway
Telex: 72640

GREAT BRITAIN

MARANTZ AUDIO U.K. Ltd
Unit 15/16
Saxon Way Industrial Estate
Moor Lane
Harmondsworth UB7 0LW
Great Britain
Telex: 935196

GREECE

SHERTON ELECTRONICS S.A.
P.O.Box 21025
Hippocrates Street 188
Athens 11471
Greece
Telex: 216.795

JAPAN

MARANTZ JAPAN, Inc.
35-1, 7-chome, Sagamiono
Sagamihara-shi, Kanagawa
Japan

KUWAIT

AL ALAMIAH ELECTRONICS
Ussama Building
Fahd al Saleem Street
P.O.Box 23781
Safat-Kuwait
Telex: 22694

ITALY

MARANTZ ITALIANA S.P.A.
Via Chiese, 74
20126 Milano
Italy

SAUDI ARABIA

AL ALAMIAH ELECTRONICS
P.O.Box 5954
University Street
Riyadh 11432
Saudi Arabia
Telex: 401530

SOUTH AFRICA

MARANTZ
DIVISION OF PHILIPS S.A.
Main Road Martindale
P.O. Box. 58088
Newville 21114
South Africa

SPAIN

PHONO S.A.
Ignacio Iglesias 10
Badalona (Barcelona)
Spain
Telex: 59355

SWEDEN

MARANTZ
DIVISION OF PHILIPS
Försäljning AB
Tegeluddsvägen 1
S-115 84 Stockholm
Sweden
Telex: 14060

SWITZERLAND

DYNAVOX ELECTRONICS
Route de Villars 105
1701 Fribourg
Switzerland
Telex: 942377

TURKEY

DOGRUOL Ltd.
I.M.C.
6 Blok N°6310
Unkapani
Istanbul
Turkey
Telex: 22085

MALTA

CACHIA & GALEA
Republic Street, 68D
Valetta
Telex: 1682

PORTUGAL

MARANTZ
Divisao philips S.A. service
Outeiro-carnaxide
2795 LinDA-A-VELHA
Telex: 43906

MC-Service

All of the above locations are fully equipped to take care of your total service needs. Because various countries have differing configuration requirements, it is necessary that you contact the service facility in your particular country. In the event that there is no service location listed for your country, please, contact the nearest facility for the necessary assistance.

In case of difficulties, do not hesitate to contact the Technical Department at abovementioned address.

MODEL PM-50 INTEGRATED AMPLIFIER

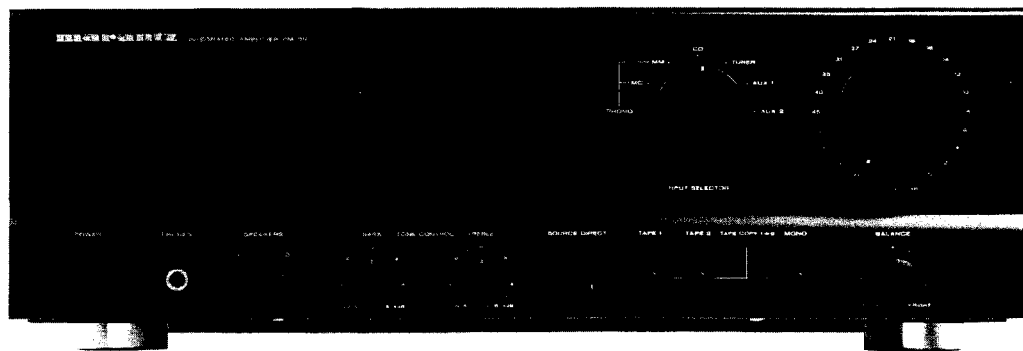

TABLE OF CONTENTS

Section	Page
1. BLOCK DIAGRAM	4
2. SCHEMATIC DIAGRAM	5
3. PARTS LOCATIONS (Pattern Side)	8
4. EXPLODED VIEW AND PARTS LIST	10
5. IDLING CURRENT ADJUSTMENT	14
6. HOW TO CHANGE THE SUPPLY VOLTAGE (A/N/T/W Version)	14
7. TEST EQUIPMENT REQUIRED FOR SERVICING	15
8. VOLTAGE CONVERSION	15
9. ELECTRICAL PARTS LIST	16

TECHNICAL SPECIFICATIONS (DIN)

Power Amplifier Section

IHF Dynamic Power		
2 ohms		: 240W
4 ohms		: 150W
8 ohms		: 95W
Power Output Per Channel		
DIN 4 ohms	1 kHz 1% THD	: 120W
RMS 4 ohms	1 kHz 0.06% THD	: 105W
DIN 8 ohms	1 kHz 1% THD	: 75W
RMS 8 ohms	1 kHz 0.06% THD	: 70W
FTC 4 ohms	20–20 kHz 0.06% THD	: 95W
FTC 8 ohms	20–20 kHz 0.03% THD	: 70W
Total Harmonic Distortion at 8 ohms		: 0.008%
I.M. Distortion at 8 ohms		: 0.008%
Damping Factor		: 100
Slew Rate		: 70 V/ μ s

Phono Amplifier Section

MM Cartridge Input		
Frequency Difference		: \pm 0.5 dB
Signal to Noise Ratio (A weighted)		: 86 dB
Input Sensitivity		: 2.5 mm
Input Impedance		: 47k Ohms
MC Cartridge Input		
Input Sensitivity		: 0.25 mV
Input Impedance		: 100 Ohms

High Level Section

Frequency Response		: 10–70 kHz
Signal to Noise Ratio (A weighted)		: 86 dB
Input Sensitivity		: 150 mV
Input Impedance		: 33k Ohms
Tape Output Level [Phono (MM) 5 mV 1 kHz Input]		: 300 mV
Tape Output Impedance (Phono)		: 220 Ohms
Tone Control Action	100 Hz	: \pm 6 dB
	10 kHz	: \pm 6 dB
Channel Separation	(CD Input at 1 kHz)	: 75 dB
	(CD Input at 10 kHz)	: 65 dB

General

Power Requirements		
2 Voltage version		: 220V/240V
4 Voltage version		: 110V–240V
Power Consumption (Rated Power)		
AB Class Moode		: 300W
A Class Moode		: –
Dimensions		
Panel Width		: 420 mm
Panel Height		: 132 mm
Depth		: 334 mm
Weight		
Unit alone		: 10 kg

Specifications and appearance are subject to change for modification without notice.

1. BLOCK DIAGRAM

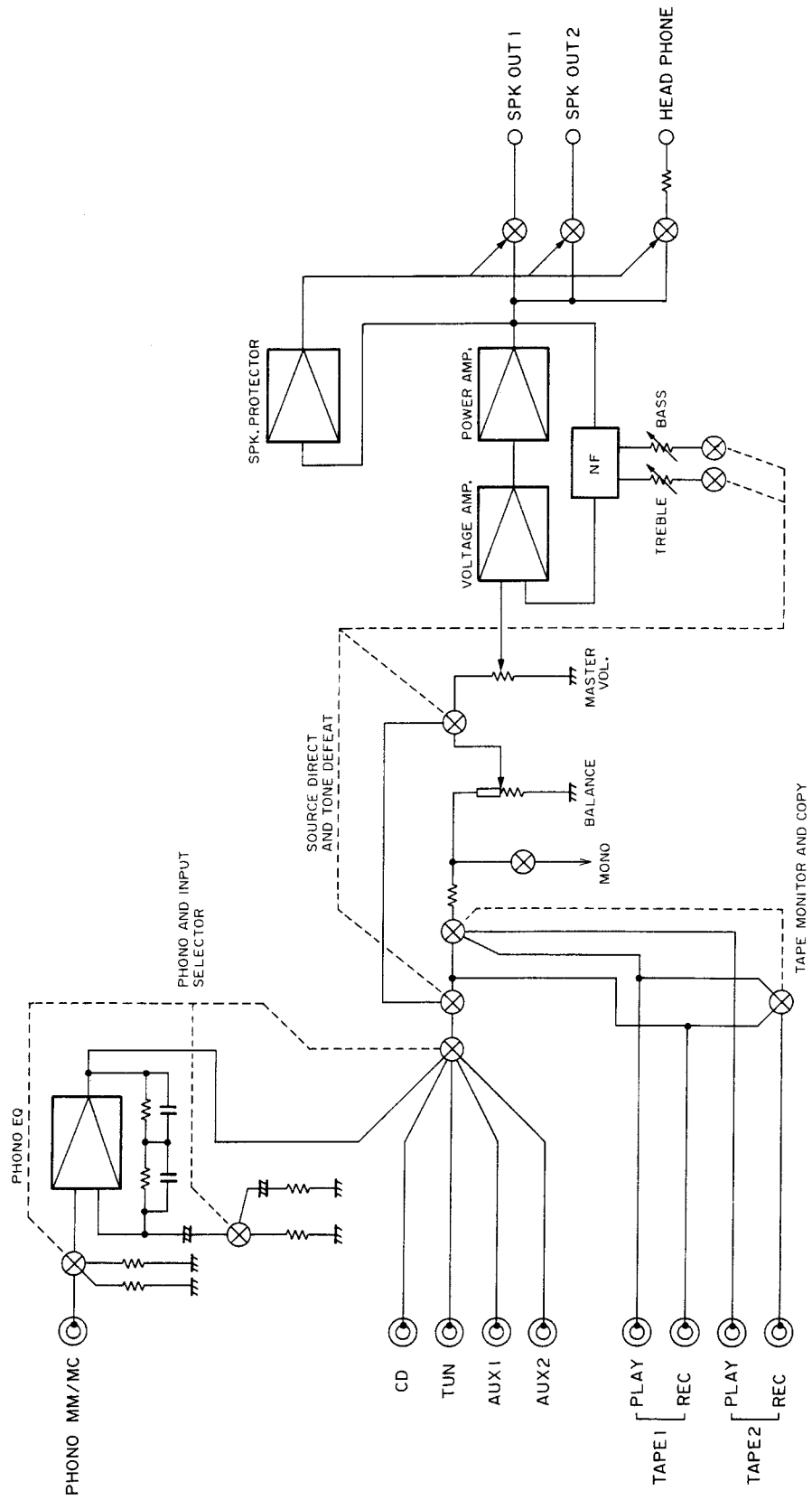

2. SCHEMATIC DIAGRAM

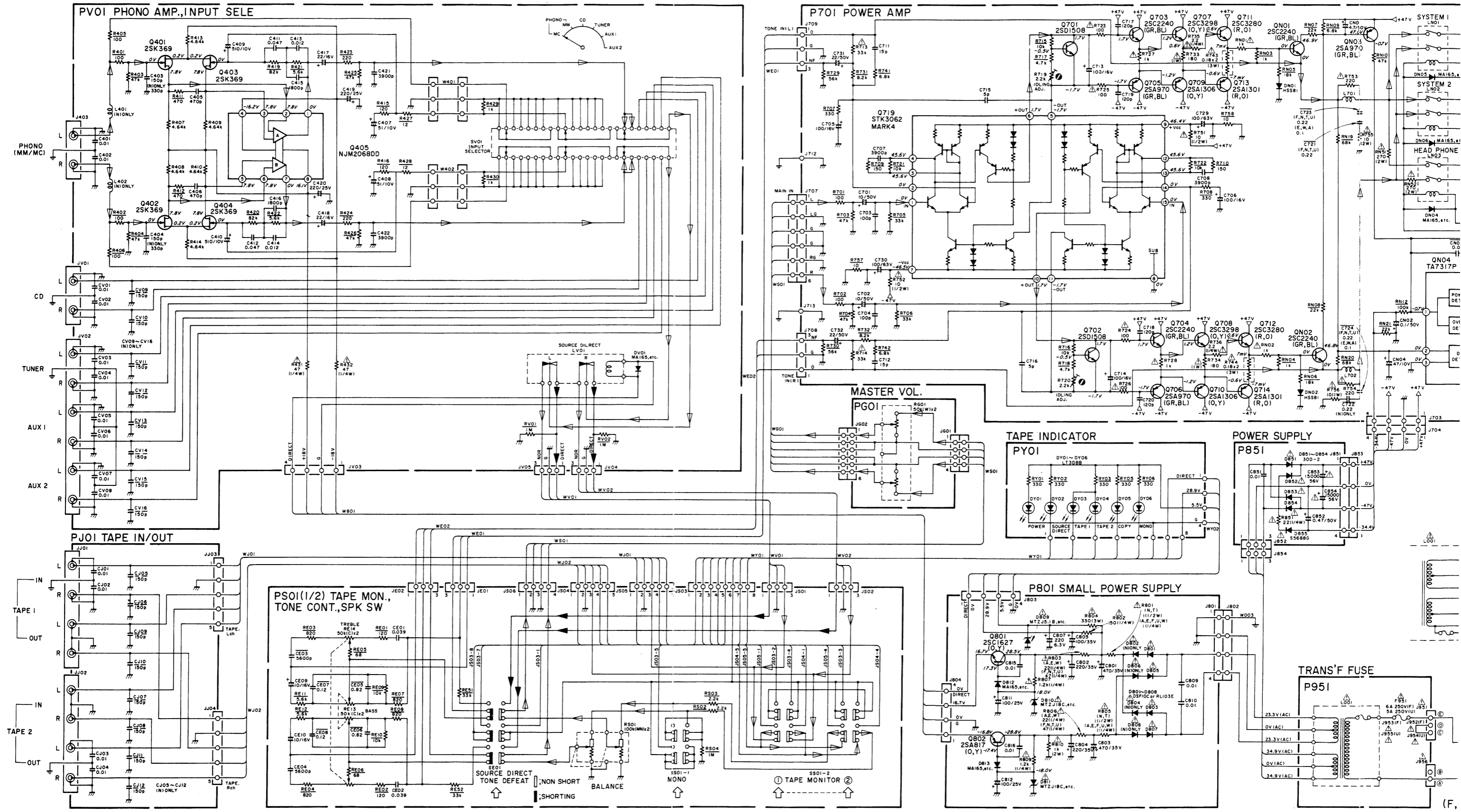

CHASSI GND
J031

MC-Service

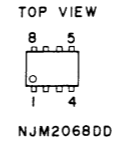
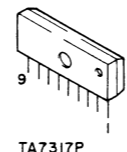

NOTE
 NORMAL SIGNAL
 SOURCE DIRECT SIGNA.

NOTE ON S.
 Symbol Δ I
 be used to r
 ponent subst
 or electrical!

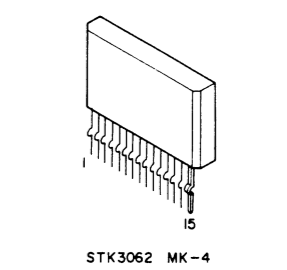
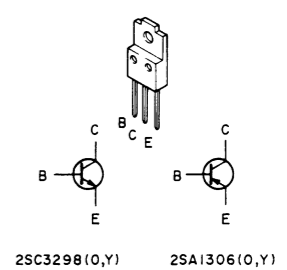
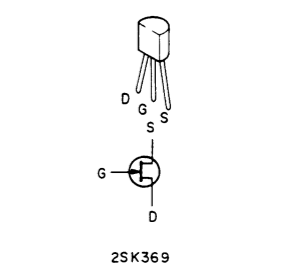
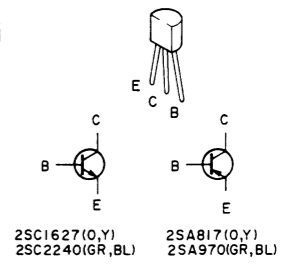
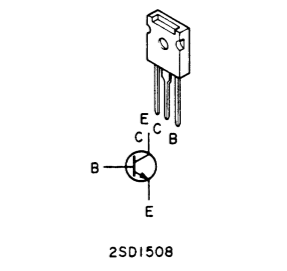
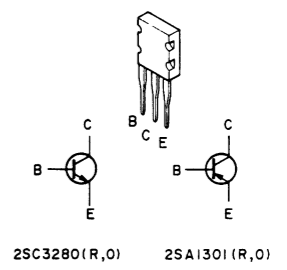
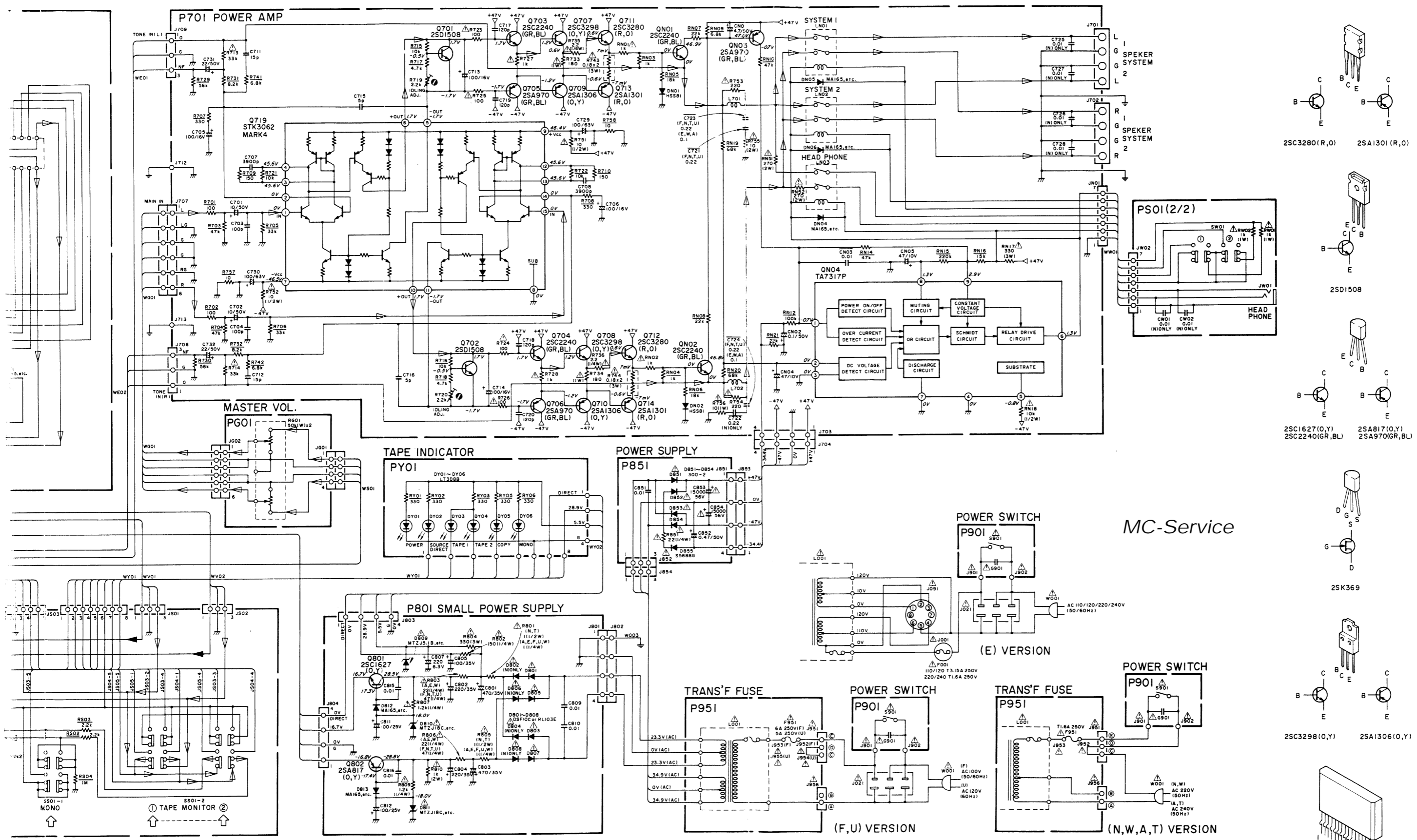

MC-Service

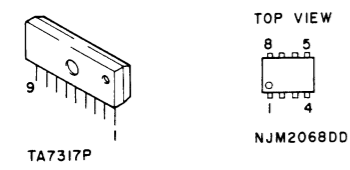

NOTE
 NORMAL SIGNAL
 SOURCE DIRECT SIGNAL

NOTE ON SAFETY:
 Symbol Fire or electrical shock hazard. Only original parts should be used to replace any part marked with symbol . Any other component substitution (other than original type), may increase risk of fire or electrical shock hazard.

3. PARTS LOCATIONS (Pattern Side)

P701 Power Amp.

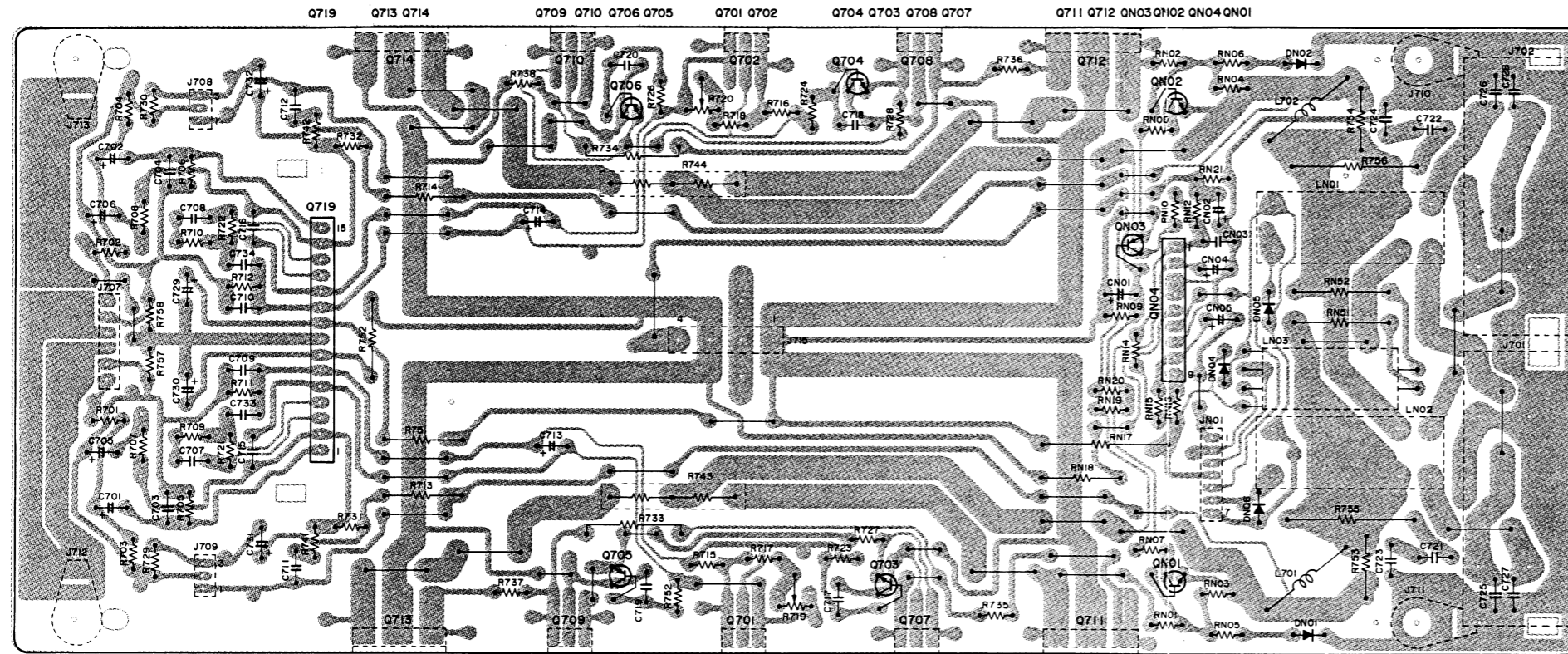

PJ01 Tape IN/OUT

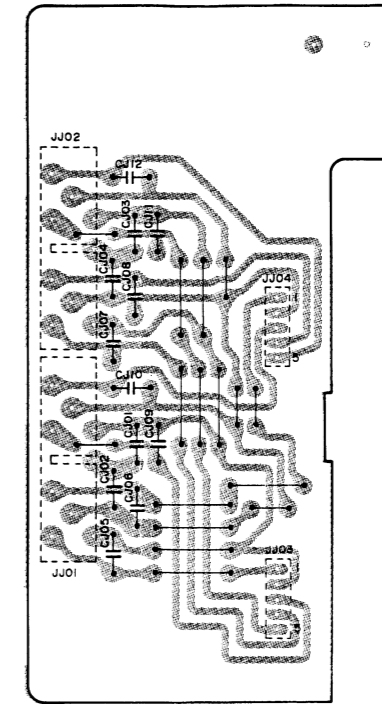

PV01 Phono Amp./Input Select

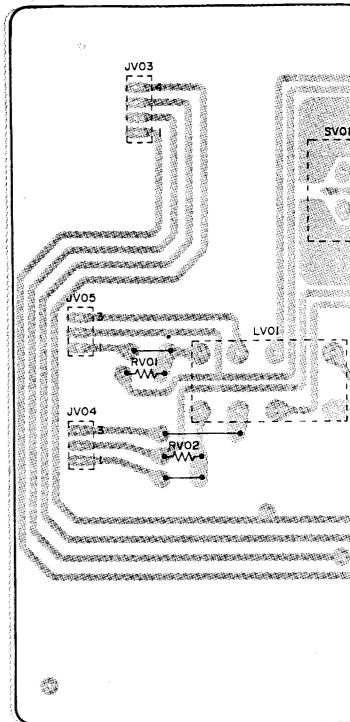

PS01 Tape Moni./Tone Cont./SPK. SW

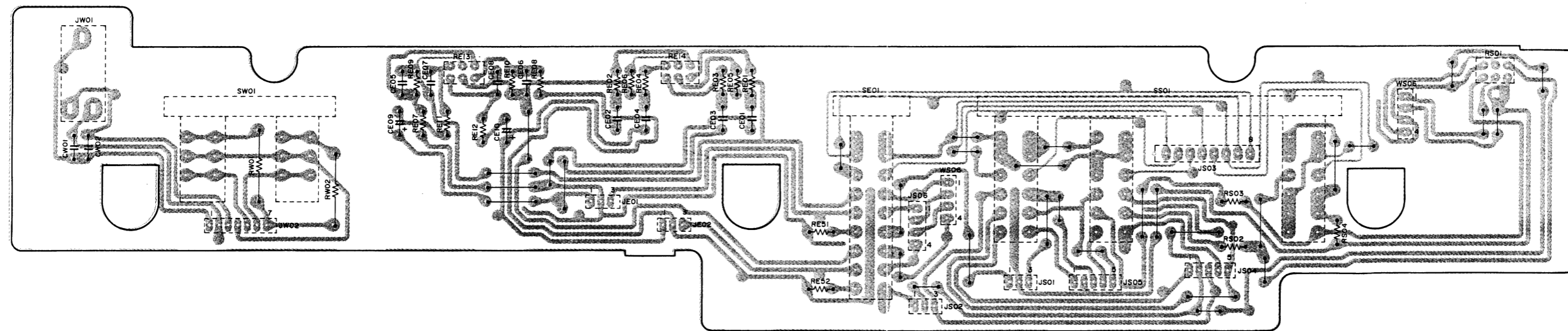

MC-Service

P851 Power Supply

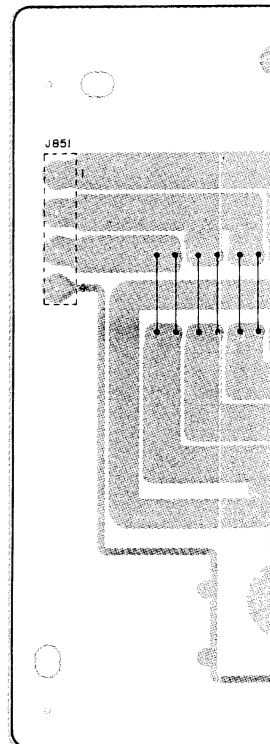

PY01 Tape Indicator

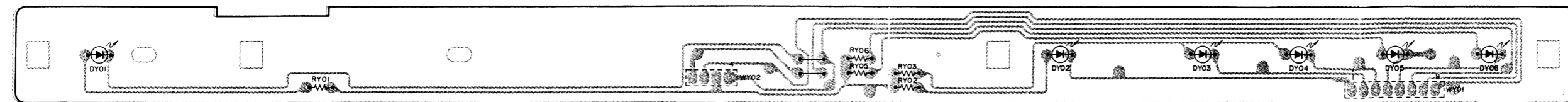

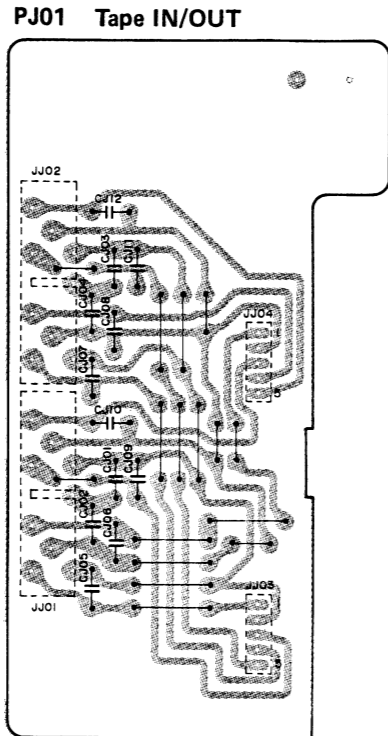
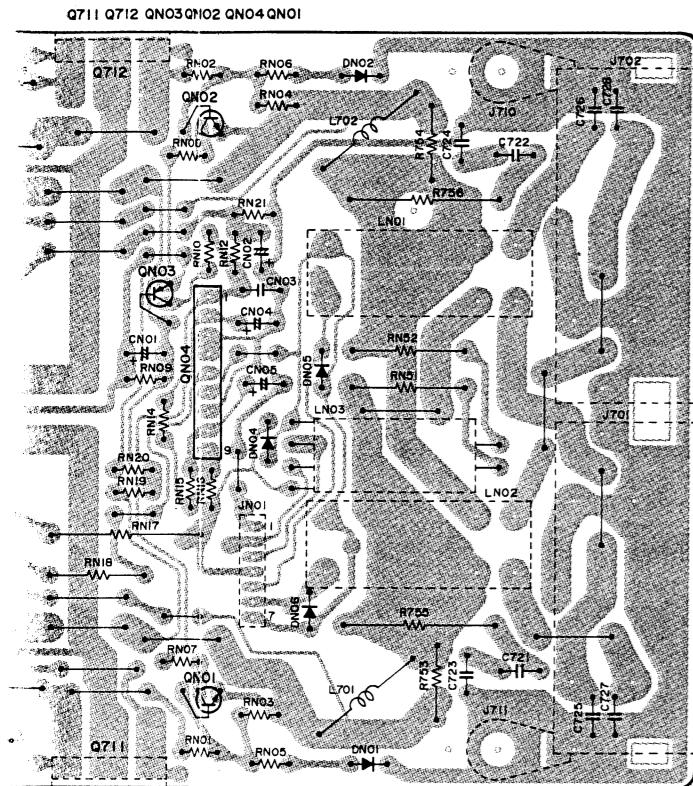

PV01 Phono Amp./Input Select

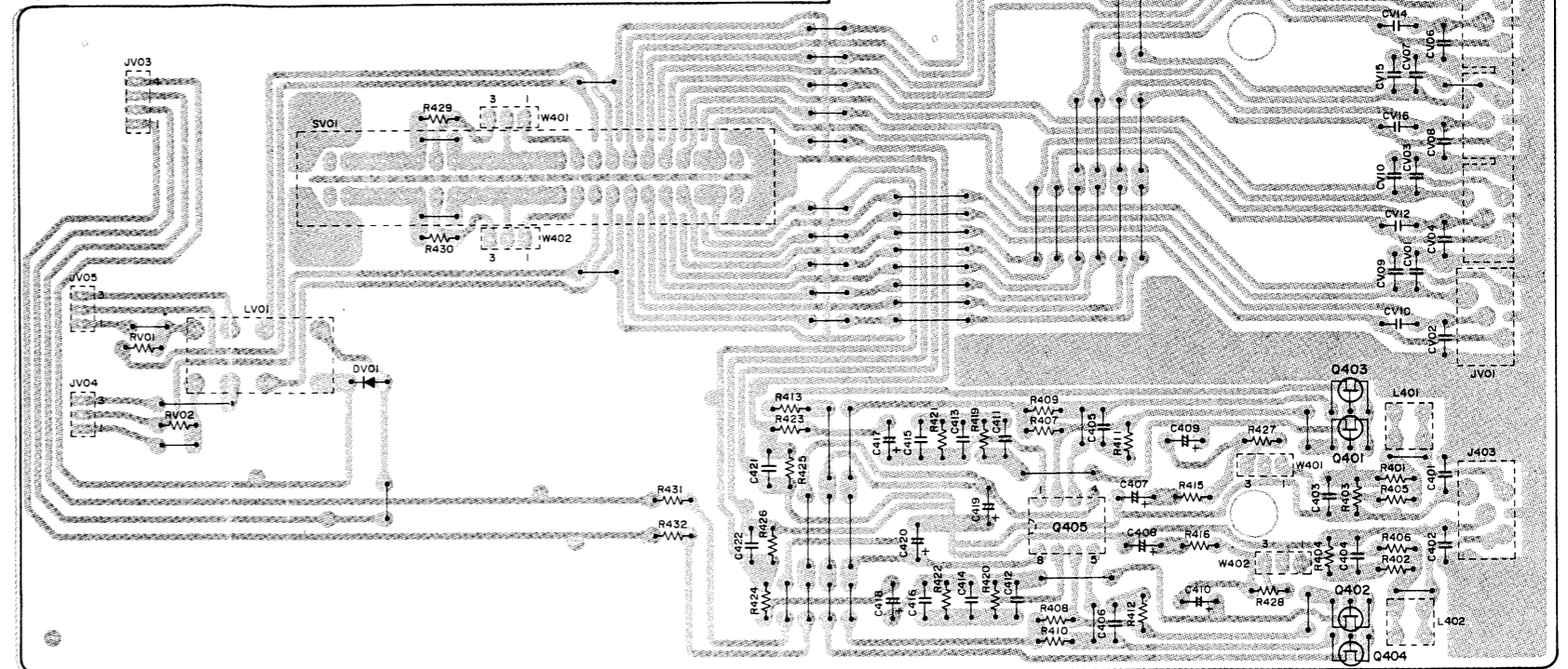

MC-Service

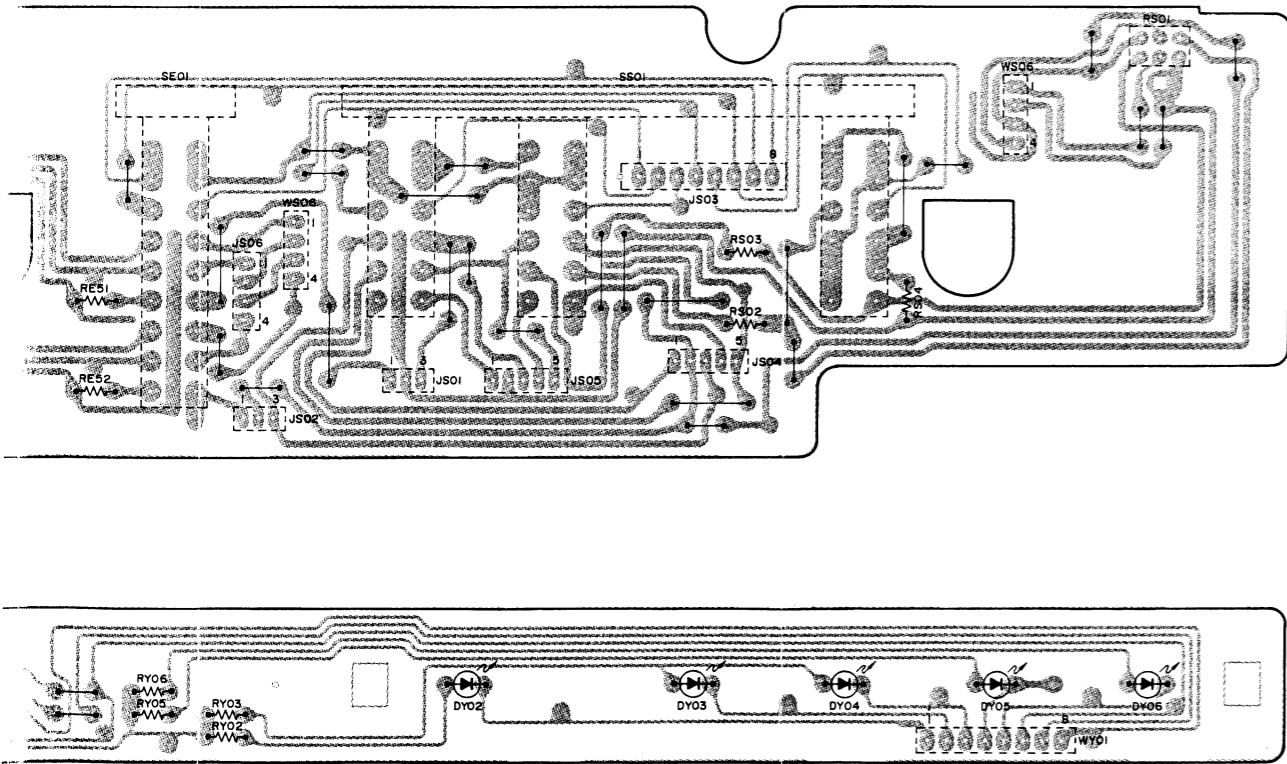

P851 Power Supply

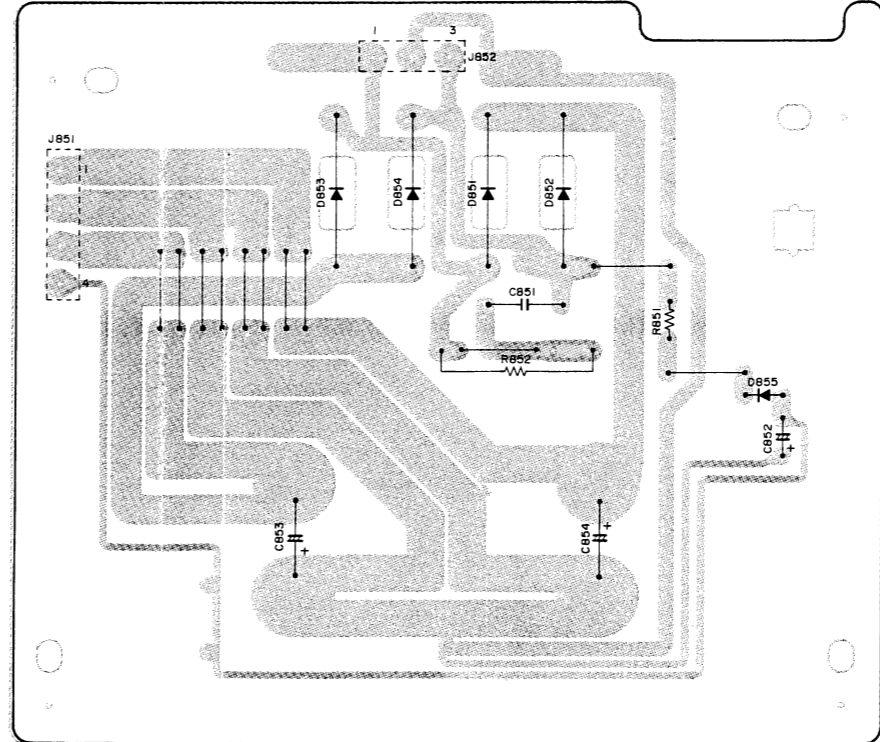

P951 Transformer/Fuse

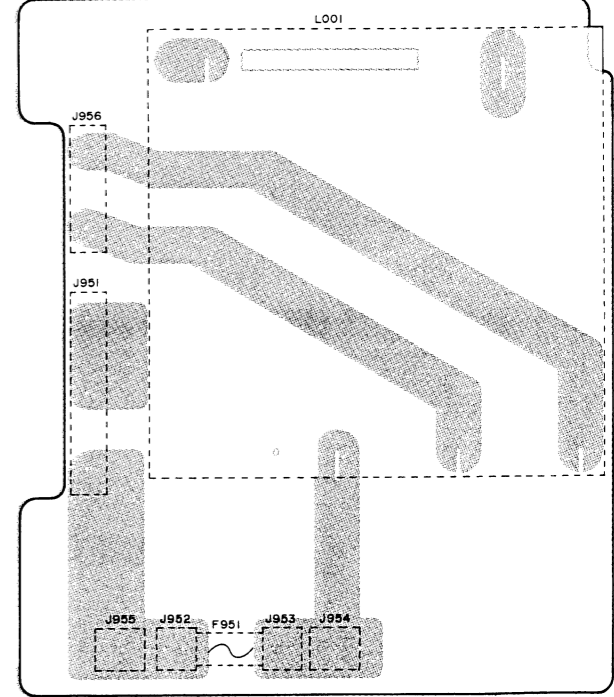

P801 Small Power Supply

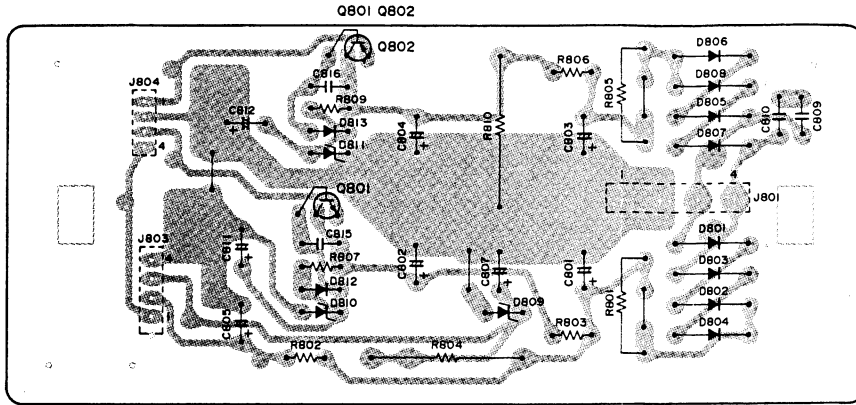

PG01 Master Volume

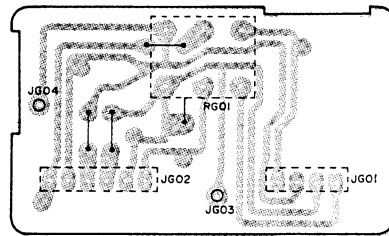

P901 Power Switch

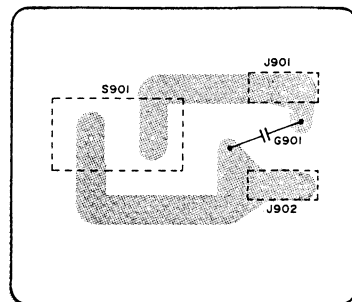

4. EXPLODED VIEW AND PARTS LIST

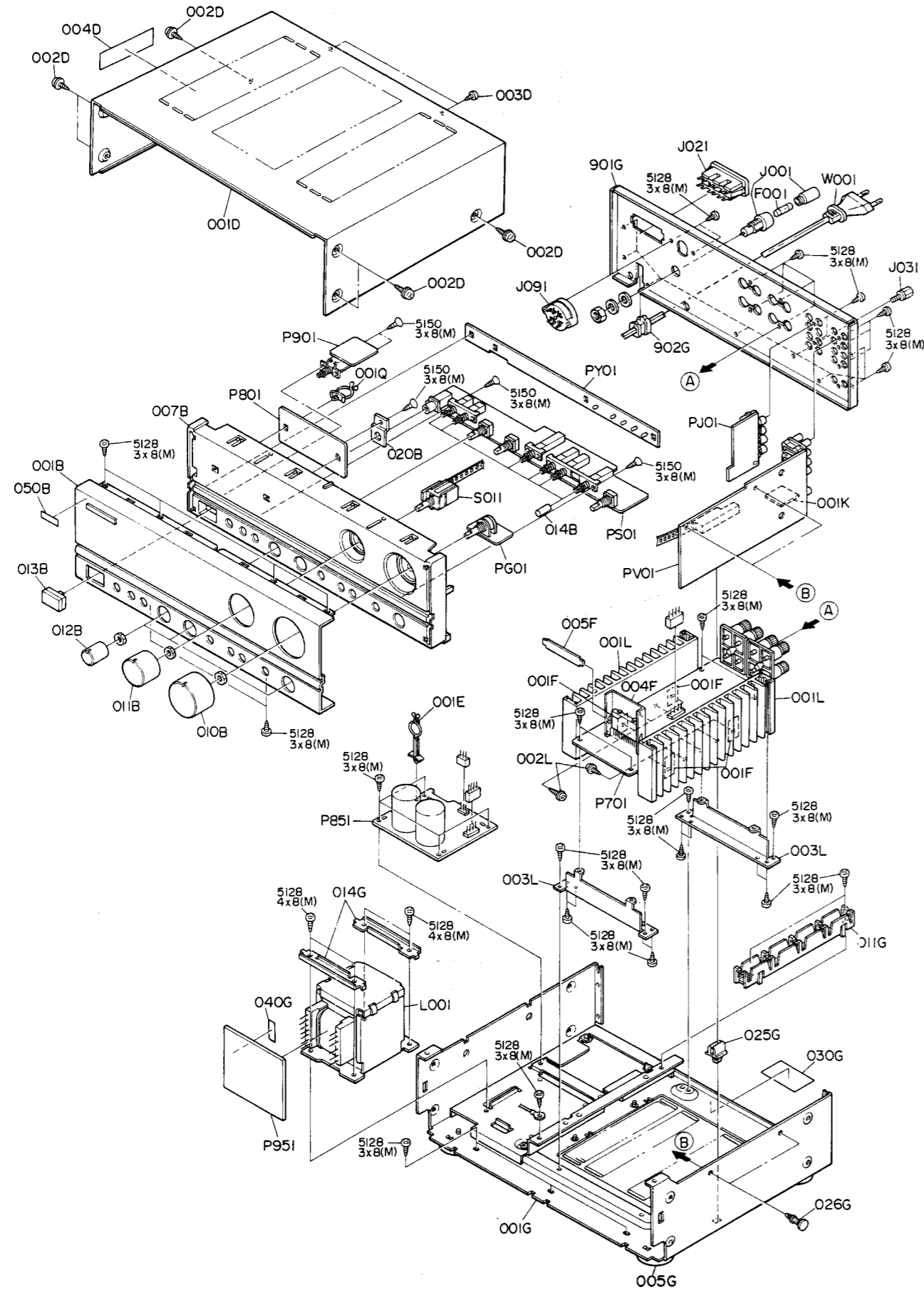

REF. DESIG.	PART NO.	DESCRIPTION
001B	4822 425 40173	Front Panel Assembly (BLK)
	4822 425 40174	Front Panel Assembly (GLD)
010B	4822 413 41544	Knob, Volume (BLK)
	4822 413 41542	Knob, Volume (GLD)
011B	4822 413 41545	Knob, Selector (BLK)
	4822 413 41582	Knob, Selector (GLD)
012B	4822 413 31551	Knob, Tone Control (BLK)
	4822 411 10051	Knob, Tone Control (GLD)
013B	4822 410 60194	Button, Power (BLK)
	4822 410 60358	Button, Power (GLD)
014B	4822 410 60343	Button, Speaker (BLK)
	4822 410 60334	Button, Speaker (GLD)
001F	4822 466 92249	Insulator
005F	4822 492 63973	Spring (Q719)
005G	4822 462 41477	Leg
902G	4822 532 60948	Bushing, AC Cord
△ F001	4822 253 30027	Fuse, T3.15A 250V [E]
△ F002	4822 253 30191	Fuse, T1.6A 250V [E]
△ J001	4822 256 30233	Jack, Fuse Holder [E]
△ J021	4822 264 30266	Jack, AC Outlet [E]
J031	4822 290 40297	Terminal, GND
△ J091	4822 272 10227	Voltage Selector [E]
△ L001	4822 146 21457	Power Transformer [A N, T, W]
	4822 146 21471	Power Transformer [E]
S011	4822 273 10194	Rotary Switch, Selector
001T	4822 736 20422	User Manual

5. IDLING CURRENT ADJUSTMENT

- (1) Before switching the power ON, set the Master Volume control to the minimum position and the Balance and Tone controls to the center positions. Also set semi-fixed resistors R719 (L CH) and R720 (L CH) on PCB P701 to the center positions.
- (2) Each of the cement resistors R743 (L CH) and R744 (R CH) on the PCB P701 is provided with three test points. Connect a digital voltmeter, set for the DC voltage input, to the test points at the two extremities of the three test points of R743 or R744.
- (3) After the setup above, switch the power ON and adjust semi-fixed resistor R719 (L CH) or R720 (R CH) on PCB P701 according to the digital voltmeter reading. The target setting value is 14 mV (38.9 mA) for both the L CH and R CH.

Please refer to the table below.

Elapsed time after power ON	Idling current setting value
30 sec. - 1 min.	13 mV
1 min. - 2 min.	14 mV
2 min. - 4 min.	14.5 mV
More than 4 min.	14 mV

Note on Safety:

Symbol Δ Fire or electrical shock hazard. Only original parts should be used to replace any part marked with symbol Δ . Any other component substitution (other than original type), may increase risk of fire or electrical shock hazard.

6. HOW TO CHANGE THE SUPPLY VOLTAGE (A/N/T/W Versions)

With the PM-50 A and T Versions, the rated supply voltage of 240V can be changed to 220V. In the same way, the 220V rated supply voltage of the PM-50 N and W Versions can be changed to 240V.

Refer to the following diagram for the voltage change procedure.

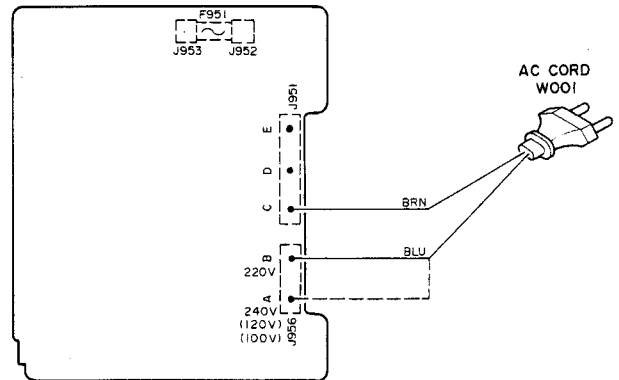

Soldered surface of P951

After binding solder around the terminal, bundle the brown wire and blue wire together and tighten them with a tightener.

Note on Terminals J951 and J956

Wrapping terminals J951 and J956 on the P951 PC board are critical components for the safety. Please observe the following caution when working these terminals.

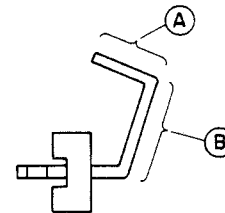

Terminal side view

Wrapping shall be performed within range A .
When binding up solder, apply solder within range B .

7. TEST EQUIPMENT REQUIRED FOR SERVICING

This table lists the test equipment required for servicing the Model PM-55 Stereo Amplifier.

Item	Use
Distortion Analyzer	Distortion measurements
Audio Oscillator	Sinewave and squarewave signal source
ACVTVM	Voltage measurements (AC)
Oscilloscope	Waveform analysis and trouble shooting and ASO aignment
Circuit Tester	Trouble shooting
DCVTVM	Voltage measurements (DC)
AC Wattmeter	Monitors primary power to amplifier
Line Voltmeter	Monitors potential of primary power to amplifier
Variable Autotransformer	Adjust level of primery power to amplifier
Shorting Plug	Shorts amplifier input to eliminate noise pickup

8. VOLTAGE CONVERSION

● EUROPEAN MODEL ONLY

To convert the unit to a different power source voltage, change the position as illustrated in the drawing below.

VOLTAGE SELECTOR

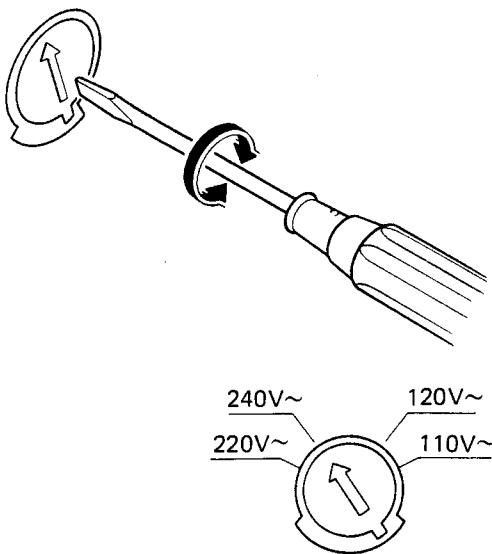

CAUTION
DISCONNECT POWER SUPPLY CORD FROM AC
OUTLET BEFORE CONVERTING VOLTAGE.

9. ELECTRICAL PARTS LIST

ASSIGNMENT OF COMMON PARTS CODES.

RESISTOR

R***: (1) GD05 --- 140, Carbon film fixed resistor, $\pm 5\%$, 1/4W

R***: (2) GD05 --- 160, Carbon film fixed resistor, $\pm 5\%$, 1/6W

① — Resistance value

Examples

① Resistance value
 0.1 Ω ...001 10 Ω ...100 1k Ω ...102 100k Ω ...104
 0.5 Ω ...005 18 Ω ...180 2.7k Ω ...272 680k Ω ...684
 1 Ω ...010 100 Ω ...101 10k Ω ...103 1M Ω ...105
 6.8 Ω ...068 390 Ω ...391 22k Ω ...223 4.7M Ω ...475

(Note) Please distinguish 1/4W from 1/6W by the shape of parts used actually.

C***: CERAMIC CAP.

(1) DD1 --- 370, Ceramic condenser
 Disc type
 Temp. coeff. P350 ~ N1000, 50V

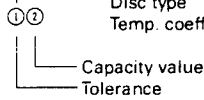

Examples

① Tolerance (Capacity deviation)
 $\pm 0.25\mu\text{F}$...0
 $\pm 0.5\mu\text{F}$...1
 $\pm 5\%$...5

* Tolerance of COMMON PARTS handled here are as follows:

0.5pF ~ 5pF... $\pm 0.25\mu\text{F}$
 6pF ~ 10pF... $\pm 0.5\mu\text{F}$
 12pF ~ 560pF... $\pm 5\%$

② Capacity value
 0.5pF...005 3pF...030 100pF...101
 1pF...010 10pF...100 220pF...221
 1.5pF...015 47pF...470 560pF...561

C***: CERAMIC CAP.

(1) DK16 --- 300, High dielectric constant ceramic condenser
 Disc type
 Temp. chara. 2B4, 50V

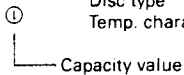

Example

② Capacity value
 100pF...101 1000pF...102 10000pF...103
 470pF...471 2200pF...222

C***: ELECTROLY CAP. (\neq), FILM CAP. (\neq)

(1) EA --- 10, Electrolytic condenser
 One-way lead type, Tolerance $\pm 20\%$

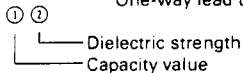

Examples

① Capacity value
 0.1 μF ...104 4.7 μF ...475 100 μF ...107
 0.33 μF ...334 10 μF ...106 330 μF ...337
 1 μF ...105 22 μF ...226 1100 μF ...108
 2200 μF ...228

② Working voltage
 6.3V...006 25V...025
 10V...010 35V...035
 16V...016 50V...050

(2) DF15 --- 350, Plastic film condenser
 One-way type, Mylar $\pm 5\%$ 50V

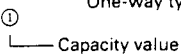

Examples

① Capacity value
 0.001 μF (1000pF)...102 0.1 μF ...104
 0.0018 μF ...182 0.56 μF ...564
 0.01 μF ...103 1 μF ...105
 0.015 μF ...153

REF. DESIG.	PART NO.	DESCRIPTION
		PG01-MASTER VOLUME CIRCUIT BOARD
RG01	4822 101 30653	Variable Resistor 50K Ω (W)x2
		PJ01-TAPE IN/OUT CIRCUIT BOARD
CJ01 }	4822 122 32486	Ceramic Cap. 0.01 μF +80% -20%
CJ04		
JJ01	4822 266 30284	Terminal, 4P; RCA Jack
JJ02	4822 266 30284	Terminal, 4P; RCA Jack
		PS01-TAPE MONI./TONE CONT./SPK. SW CIRCUIT BOARD
		PS01-CAPACITORS
CE01	4822 121 43133	Film 0.039 μF $\pm 5\%$
CE02	4822 121 43133	Film 0.039 μF $\pm 5\%$
CE03	4822 121 51389	Film 5600pF $\pm 5\%$
CE04	4822 121 51389	Film 5600pF $\pm 5\%$
CE09	4822 124 90352	Elect 10 μF 16V
CE10	4822 124 90352	Elect 10 μF 16V
CW01	4822 122 32486	Ceramic 0.01 μF +80% -20% [N]
CW02	4822 122 32486	Ceramic 0.01 μF +80% -20% [N]
		PS01-RESISTORS
RE13	4822 101 30654	50K Ω (C)x2, Variable; BUSS
RE14	4822 101 30654	50K Ω (C)x2, Variable; Treble
RS01	4822 101 30652	100K Ω (MN)x2, Variable; Balance
Δ RW01	4822 116 60331	1K Ω $\pm 5\%$ 1W
Δ RW02	4822 116 60331	1K Ω $\pm 5\%$ 1W
		PS01-MISCELLANEOUS
JW01	4822 267 31126	Jack, Headphone (BLK)
	4822 267 31119	Jack, Headphone (GLD)
SE01	4822 276 12658	Push Switch, Direct/Tone Defeat
SS01	4822 276 12657	Push Switch, Mono/Tape Monitor
SW01	4822 276 12428	Push Switch
		PV01-PHONO AMP./INPUT SELECT CIRCUIT BOARD
		PV01-CAPACITORS
C401	4822 122 32486	Ceramic 0.01 μF +80% -20%
C402	4822 122 32486	Ceramic 0.01 μF +80% -20%
C403	4822 121 51037	Film 150pF $\pm 5\%$ [A,E,T,W]
C404	4822 121 51037	Film 150pF $\pm 5\%$ [A,E,T,W]
C405	4822 121 41518	Film 470pF $\pm 5\%$
C406	4822 121 41518	Film 470pF $\pm 5\%$
C407	4822 124 22278	Elect 51 μF 10V
C408	4822 124 22278	Elect 51 μF 10V
C409	4822 124 22279	Elect 510 μF 10V
C410	4822 124 22279	Elect 510 μF 10V

REF. DESIG.	PART NO.	DESCRIPTION		
C411	4822 121 42764	Film	0.047 μ F	\pm 5%
C412	4822 121 42764	Film	0.047 μ F	\pm 5%
C413	4822 121 42755	Film	0.012 μ F	\pm 5%
C414	4822 121 42755	Film	0.012 μ F	\pm 5%
C415	4822 121 42758	Film	1800pF	\pm 5%
C416	4822 121 42758	Film	1800pF	\pm 5%
C417	4822 124 90358	Elect	22 μ F	16V
C418	4822 124 90358	Elect	22 μ F	16V
C419	4822 124 90365	Elect	220 μ F	25V
C420	4822 124 90365	Elect	220 μ F	25V
C421	4822 121 42763	Film	3900pF	\pm 5%
C422	4822 121 42763	Film	3900pF	\pm 5%
CV01 }	4822 122 32486	Ceramic	0.01 μ F	+80% -20%
CV08				
PV01-RESISTORS				
R407	4822 116 53691	4.64K Ω	\pm 1%	1/6W
R408	4822 116 53691	4.64K Ω	\pm 1%	1/6W
R409	4822 116 53691	4.64K Ω	\pm 1%	1/6W
R410	4822 116 53691	4.64K Ω	\pm 1%	1/6W
R413	4822 116 53691	4.64K Ω	\pm 1%	1/6W
R414	4822 116 53691	4.64K Ω	\pm 1%	1/6W
Δ R431	4822 111 90731	47 Ω	\pm 2%	1/4W, Fuse
Δ R432	4822 111 90731	47 Ω	\pm 2%	1/4W, Fuse
PV01-SEMICONDUCTORS				
DV01	4822 130 33305	Diode	MA165, etc.	
Q401	4822 130 42839	F.E.T.	2SK369(BL)	
Q402	4822 130 42839	F.E.T.	2SK369(BL)	
Q403	4822 130 42839	F.E.T.	2SK369(BL)	
Q404	4822 130 42839	F.E.T.	2SK369(BL)	
Q405	4822 209 73064	IC	NJM2068DD	
PV01-MISCELLANEOUS				
J403	4822 266 30282	Terminal, 2P; RCA Jack		
JV01	4822 266 30282	Terminal, 2P; RCA Jack		
JV02	4822 266 30285	Terminal, 6P; RCA Jack		
L401	4822 156 11019	Choke Coil, 320 μ H [N]		
L402	4822 156 11019	Choke Coil, 320 μ H [N]		
LV01	4822 280 20195	Relay		
SV01	4822 277 21352	Slide Switch		
PY01-TAPE INDICATOR CIRCUIT BOARD				
DY01 }	4822 130 80326	L.E.D.	LT3D8B	
DY06				
P701-POWER AMP. CIRCUIT BOARD				
P701-CAPACITORS				
CN01	4822 124 22274	Elect	4.7 μ F	50V
CN02	4822 124 90351	Elect	0.1 μ F	50V
CN04	4822 124 22275	Elect	47 μ F	10V
CN05	4822 124 22275	Elect	47 μ F	10V

REF. DESIG.	PART NO.	DESCRIPTION		
C701	4822 124 23082	Elect	10 μ F	50V
C702	4822 124 23082	Elect	10 μ F	50V
C703	4822 121 51008	Film	100pF	\pm 5%
C704	4822 121 51008	Film	100pF	\pm 5%
C705	4822 124 90354	Elect	100 μ F	16V
C706	4822 124 90354	Elect	100 μ F	16V
C707	4822 121 42763	Film	3900pF	\pm 5%
C708	4822 121 42763	Film	3900pF	\pm 5%
C711	4822 121 43129	Film	15pF	\pm 10%
C712	4822 121 43129	Film	15pF	\pm 10%
C713	4822 124 90354	Elect	100 μ F	16V
C714	4822 124 90354	Elect	100 μ F	16V
C715	4822 121 43127	Film	5pF	\pm 10%
C716	4822 121 43127	Film	5pF	\pm 10%
C717	4822 121 43126	Film	120pF	\pm 5%
C718	4822 121 43126	Film	120pF	\pm 5%
C719	4822 121 43126	Film	120pF	\pm 5%
C720	4822 121 43126	Film	120pF	\pm 5%
C725	4822 122 32486	Ceramic 0.01 μ F +80% -20% [N]		
C726	4822 122 32486	Ceramic 0.01 μ F +80% -20% [N]		
C727	4822 122 32486	Ceramic 0.01 μ F +80% -20% [N]		
C728	4822 122 32486	Ceramic 0.01 μ F +80% -20% [N]		
C729	4822 124 22572	Elect	100 μ F	63V
C730	4822 124 22572	Elect	100 μ F	63V
C731	4822 124 90362	Elect	22 μ F	50V
C732	4822 124 90362	Elect	22 μ F	50V
P701-RESISTORS				
Δ RN01	4822 111 91257	1K Ω	\pm 5%	1/6W
Δ RN02	4822 111 91257	1K Ω	\pm 5%	1/6W
Δ RN17	4822 116 80648	330 Ω	\pm 5%	3W, Metal
Δ RN18	4822 116 52452	10K Ω	\pm 5%	1/2W
Δ RN51	4822 116 60455	270 Ω	\pm 5%	2W
Δ RN52	4822 116 60455	270 Ω	\pm 5%	2W
Δ R713	4822 116 80647	33K Ω	\pm 5%	1/2W
Δ R714	4822 116 80647	33K Ω	\pm 5%	1/2W
R719	4822 100 20681	2.2K Ω , Trimming		
R720	4822 100 20681	2.2K Ω , Trimming		
Δ R723	4822 111 91285	100 Ω	\pm 5%	1/6W
Δ R724	4822 111 91285	100 Ω	\pm 5%	1/6W
Δ R725	4822 111 91285	100 Ω	\pm 5%	1/6W
Δ R726	4822 111 91285	100 Ω	\pm 5%	1/6W
Δ R727	4822 111 91257	1K Ω	\pm 5%	1/6W
Δ R728	4822 111 91257	1K Ω	\pm 5%	1/6W
Δ R733	4822 116 60342	180 Ω	\pm 5%	1W
Δ R734	4822 116 60342	180 Ω	\pm 5%	1W
Δ R735	4822 116 52348	2.2 Ω	\pm 5%	1/4W
Δ R736	4822 116 52348	2.2 Ω	\pm 5%	1/4W
Δ R743	4822 116 82049	0.18 Ω x2	\pm 10%	3W
Δ R744	4822 116 82049	0.18 Ω x2	\pm 10%	3W
Δ R751	4822 116 60313	10 Ω	\pm 5%	1/2W, Fusible
Δ R752	4822 116 60313	10 Ω	\pm 5%	1/2W, Fusible
Δ R753	4822 111 91405	220 Ω	\pm 5%	1/6W
Δ R754	4822 111 91405	220 Ω	\pm 5%	1/6W
Δ R755	4822 111 90726	10 Ω	\pm 5%	2W
Δ R756	4822 111 90726	10 Ω	\pm 5%	2W
P701-SEMICONDUCTORS				
DN01	4822 130 80837	Diode	HSS81	
DN02	4822 130 80837	Diode	HSS81	
DN04	4822 130 33305	Diode	MA165, etc.	
DN05	4822 130 33305	Diode	MA165, etc.	
DN06	4822 130 33305	Diode	MA165, etc.	

REF. DESIG.	PART NO.	DESCRIPTION
QN01	4822 130 43233	Transistor 2SC2240(GR, BL)
QN02	4822 130 43233	Transistor 2SC2240(GR, BL)
QN03	4822 130 42951	Transistor 2SA970(GR, BL)
QN04	4822 209 83312	IC TA7317P
Q701	4822 130 60526	Transistor 2SD1508
Q702	4822 130 60526	Transistor 2SD1508
Q703	4822 130 43233	Transistor 2SC2240(GR, BL)
Q704	4822 130 43233	Transistor 2SC2240(GR, BL)
Q705	4822 130 42951	Transistor 2SA970(GR, BL)
Q706	4822 130 42951	Transistor 2SA970(GR, BL)
Q707	4822 130 60525	Transistor 2SC3298(O, Y)
Q708	4822 130 60525	Transistor 2SC3298(O, Y)
Q709	4822 130 60524	Transistor 2SA1306(O, Y)
Q710	4822 130 60524	Transistor 2SA1306(O, Y)
Q711	4822 130 60116	Transistor 2SC3280(R, O)
Q712	4822 130 60116	Transistor 2SC3280(R, O)
Q713	4822 130 60109	Transistor 2SA1301(R, O)
Q714	4822 130 60109	Transistor 2SA1301(R, O)
Q719	4822 209 73065	IC STK3062 MARK4
P701-MISCELLANEOUS		
J701	4822 290 60837	Terminal, Speaker [A, E, T, W]
	4822 290 60841	Terminal, Speaker [N]
J702	4822 290 60836	Terminal, Speaker [A, E, T, W]
	4822 290 60839	Terminal, Speaker [N]
LN01	4822 280 20197	Relay
LN02	4822 280 20197	Relay
LN03	4822 280 20196	Relay
L701	4822 157 51739	Coil, Speaker
L702	4822 157 51739	Coil, Speaker
P801-SMALL POWER SUPPLY CIRCUIT BOARD		
P801-CAPACITORS		
C801	4822 124 41541	Elect 470 μ F 35V
C802	4822 124 41538	Elect 220 μ F 35V
C803	4822 124 41541	Elect 470 μ F 35V
C804	4822 124 41538	Elect 220 μ F 35V
C805	4822 124 41536	Elect 100 μ F 35V
C807	4822 124 41537	Elect 220 μ F 6.3V
C809	4822 122 32486	Ceramic 0.01 μ F +80% -20%
C810	4822 122 32486	Ceramic 0.01 μ F +80% -20% [N, T]
C811	4822 124 41535	Elect 100 μ F 25V
C812	4822 124 41535	Elect 100 μ F 25V
C815	4822 122 32486	Ceramic 0.01 μ F +80% -20%
C816	4822 122 32486	Ceramic 0.01 μ F +80% -20%
P801-RESISTORS		
Δ R801	4822 116 52976	1 Ω \pm 5% $\frac{1}{4}$ W [A, E, W]
	4822 116 60306	1 Ω \pm 5% $\frac{1}{4}$ W, Fusible [N, T]
Δ R802	4822 116 82051	150 Ω \pm 2% $\frac{1}{4}$ W, Fuse
Δ R803	4822 116 53479	22 Ω \pm 5% $\frac{1}{4}$ W [A, E, W]
	4822 111 90731	47 Ω \pm 2% $\frac{1}{4}$ W, Fuse [N, T]
Δ R804	4822 116 80648	330 Ω \pm 5% 3W, Metal
Δ R805	4822 116 52976	1 Ω \pm 5% $\frac{1}{4}$ W, [A, E, W]
	4822 116 60306	1 Ω \pm 5% $\frac{1}{2}$ W, Fusible [N, T]
Δ R806	4822 116 53479	22 Ω \pm 5% $\frac{1}{4}$ W
	4822 111 90731	47 Ω \pm 2% $\frac{1}{4}$ W, Fuse [N, T]
Δ R807	4822 111 91423	1.2K Ω \pm 5% $\frac{1}{4}$ W
Δ R809	4822 111 91423	1.2K Ω \pm 5% $\frac{1}{4}$ W
Δ R810	4822 116 60332	1K Ω \pm 5% 2W

REF. DESIG.	PART NO.	DESCRIPTION
P801-SEMICONDUCTORS		
Δ D801	4822 130 32508	Diode DSF10C, etc.
Δ D802	4822 130 32508	Diode DSF10C, etc. [N, T]
Δ D803	4822 130 32508	Diode DSF10C, etc.
Δ D804	4822 130 32508	Diode DSF10C, etc. [N, T]
Δ D805	4822 130 32508	Diode DSF10C, etc.
Δ D806	4822 130 32508	Diode DSF10C, etc. [N, T]
Δ D807	4822 130 32508	Diode DSF10C, etc.
Δ D808	4822 130 32508	Diode DSF10C, etc. [N, T]
Δ D809	4822 130 80317	Zener MTZJ5.1B, etc.
Δ D810	4822 130 80838	Zener MTZJ18C, etc.
Δ D811	4822 130 80838	Zener MTZJ18C, etc.
D812	4822 130 33305	Diode MA165, etc.
D813	4822 130 33305	Diode MA165, etc.
Q801	4822 130 60696	Transistor 2SC1627(O, Y)
Q802	4822 130 60693	Transistor 2SA817(O, Y)
P851-POWER SUPPLY CIRCUIT BOARD		
C851	4822 122 30043	Ceramic Cap. 0.01 μ F +80% -20%
C852	4822 124 22273	Elect Cap. 0.47 μ F 50V
Δ C853	4822 124 23081	Elect Cap. 15000 μ F 56V
Δ C854	4822 124 23081	Elect Cap. 15000 μ F 56V
Δ R851	4822 113 90119	Fuse Resistor 22 Ω \pm 2% $\frac{1}{4}$ W
Δ D851	4822 130 33864	Diode 30D-2
Δ D852	4822 130 33864	Diode 30D-2
Δ D853	4822 130 33864	Diode 30D-2
Δ D854	4822 130 33864	Diode 30D-2
Δ D855	4822 130 80839	Diode S5688G
P901-POWER SWITCH CIRCUIT BOARD		
Δ G901	4822 122 33276	Ceramic Cap. 0.01 μ F \pm 20%
Δ S901	4822 276 11798	Push Switch, Power
P951-TRANSFORMER/FUSE CIRCUIT BOARD [A, N, T, W]		
Δ F951	4822 253 30191	Fuse T1.6A 250V
Δ L001	4822 146 21457	Power Transformer

NOTE ON SAFETY:

Symbol Δ Fire or electrical shock hazard. Only original parts should be used to replace any part marked with symbol Δ . Any other component substitution (other than original type), may increase risk of fire or electrical shock hazard.

MC-Service



marantz®